

Kemet

Precision Lapping | Polishing | Cleaning | Materialography

PRECISION LAPPING AND POLISHING SYSTEMS



Kemet International Ltd, Parkwood Trading Estate, Maidstone, Kent, ME15 9NJ, UK

+44 (0) 1622 755287 sales@kemet.co.uk www.kemet.co.uk

Contents

MACHINES 1-12

15" to 120" Lapping Machines	1-5
Spherical Lapping	6
Match Lapping	7
Small Lapping Machine	8
Dual Face Lapping	8
Thin Section Lapping	9
Chemical Mechanical Polishing	9-10
Bespoke Lapping Machines	10
Portable Valve Grinding Machines	11-12

CONSUMABLES 13-22

Lapping Plates	13-15
Cast Iron Plates	14-15
Conditioning Rings	15
Liquid Diamond	16
Lubricating Fluids	17
Conventional Abrasives	17-18
Abrasive Pastes & Powders	18
Lapping Oil	18
Diamond Compound / Paste	19
Lapping Film	19-20
Diamond Grinding Pads	20
Polishing Pads	21
Workholding & Fixtures	22
Polishing Stand with Paper	22

ACCESSORIES 23-26

Dispenser Systems	23-24
Lapping Machine Maintenance	24
Flatness Measuring Equipment	24-25
Portable / Hand Lapping Kits	26

CLEANING & TECHNICAL SUPPORT 27-31

Ultrasonic Cleaners	27-28
Lapping Service	29
Kemet Technical Support	30
Training & Quality Assurance	31

Ordering Information

Telephone:

+44(0)1622 607507 Sales Desk - Direct Line
 +44(0)1622 755287 Enquiries & Technical Support

Email:

sales@kemet.co.uk

Website:

www.kemet.co.uk

Post

Kemet International Ltd
 Cuxton Road, Parkwood Trading Estate,
 Maidstone, Kent ME15 9NJ, UK



Catalogue version: 2210



**Free Sample Testing
 To Find Your Optimum
 Lapping Solution**
 (see page 29)

**NEW!
 OptiPol
 Liquid Diamond**
 (see page 16)



Kemet Precision Lapping and Polishing Systems

Since 1938, Kemet has been at the forefront of precision polishing technology, producing diamond pastes, slurries and composite lapping and polishing materials in our purpose built facilities, strictly manufactured to ISO 9001:2015 quality standards. Kemet Precision Lapping and Polishing Systems offer the most efficient and reliable method of producing precise surface geometry and finish whether flat, contoured or spherical. Our machines and systems are at the forefront of today's advanced lapping technology, especially when used with Kemet Diamond products. Kemet Diamond quality and grading enables reliable precision lapping to be performed in production situations.

Now a truly international organisation, Kemet's activities span the world, spearheaded by companies in nine countries, all sharing the same commitment to customer support. This, along with more than 80 years of experience, means Kemet are here to provide you with the technical support to overcome all your lapping, polishing and cleaning challenges.

Industries and Applications

Aerospace

Pumps and Valves
Turbine Parts
Engine Assemblies
Spacers

Medical Devices

Fibre Scopes
Surgical Instruments
Hip and Knee Joints
Pacemaker Parts

Electronics

Disc Drive Heads
CD Moulds
Laminations
Smart Phones

Technical Ceramics

Alumina - Zirconia
Silicon Carbide
Piezo Ceramics
Ferrite

Electro Optics

Plano Optics
Laser Rods and Prisms
Fibre Optics
Sensors
Sapphire
ALN

Tool and Die

Moulds and Inserts
Printing Plates
Slitter Knives
Extrusion Dies
Coining Dies

Pumps & Valves

Fuel Pumps
Hydraulic Pumps
Mechanical Seals
Gate Valves
Valve Service

Automotive

Diesel Injectors
Airbag Initiators
Piston Rings
Fuel Pumps

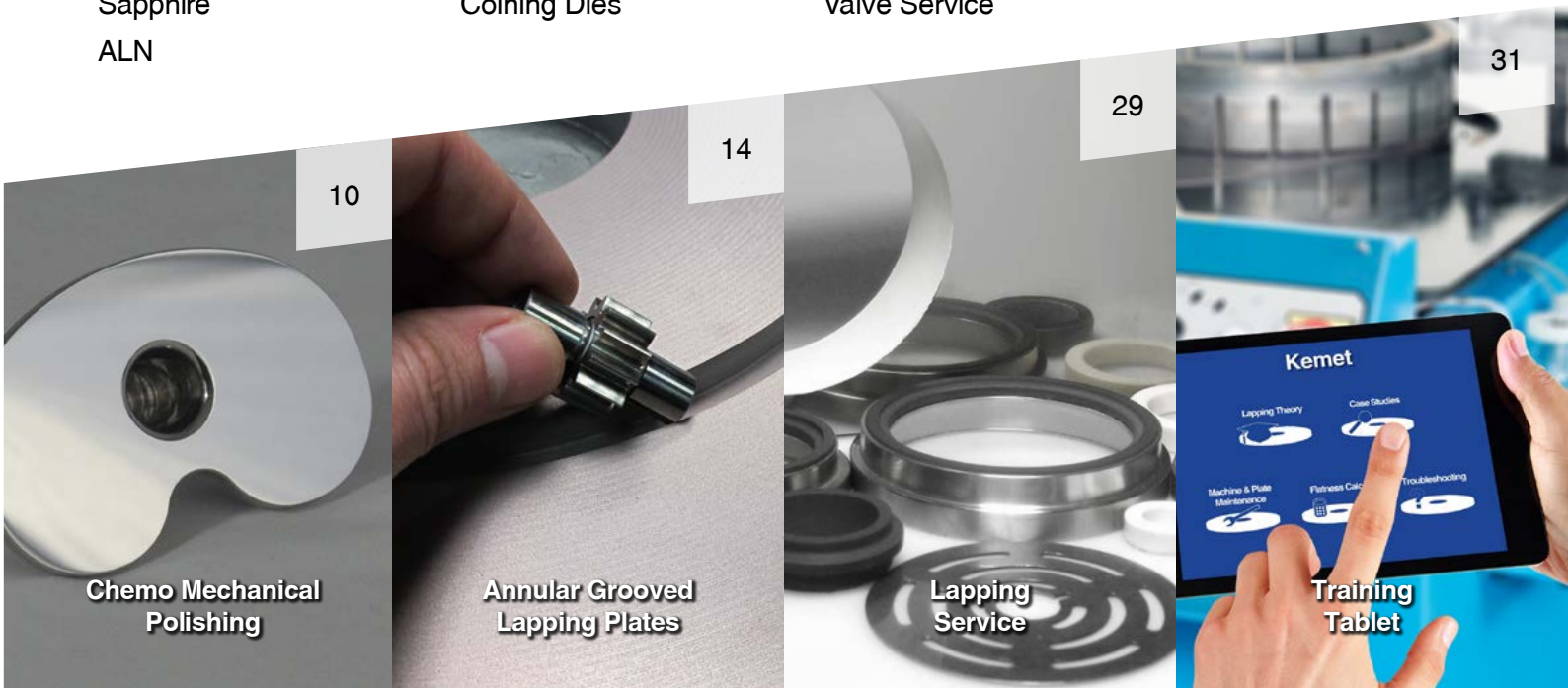

Chemo Mechanical Polishing

Annular Grooved Lapping Plates

Lapping Service

Training Tablet

Lapping Machines

Kemet's Advanced Lapping Technology

Kemet offers a comprehensive range of standard lapping and polishing systems for use across all industrial sectors. Special purpose machines can also be developed for specific applications.

Benefits:

- Faster polishing process
- One operation surface finish
- Faster material removal
- Cleaner environment conditions
- Significant reduction in lapping costs
- Reduced inspection requirements
- Optimum geometry and surface finish
- Better utilisation of machine time
- Pre set parameters
- Reduced rejections
- Semi skilled operation

Lapping Machine Options

Open Face

The open face machines are for use where work pieces are either large in size and can be lapped under their own weight or where pressure application by hand weights is sufficient.



Pneumatic Lift

The pneumatic lift machines will raise and lower the weights and also apply pressure where necessary. All are fitted with mandatory safety controls.



Kemet Lapping Machine Capacity Chart

Components per conditioning ring based on typical loading of approximately 60% ring surface area.

Machine Model (No of Rings)	Diameter of Parts (mm)																									
	6	7.5	9	10.5	12	13.5	15	18	22	26	30	34	38	42	46	50	54	60	70	80	90	100	110	120	130	140
15 (3 Rings)	275	175	118	86	60	50	40	27	18	12	10	8	6	5	4	3	2	2	2	1	1	1	1	1	1	1
20 (3 Rings)	-	-	-	-	150	114	90	63	39	33	21	17	14	10	9	7	6	5	3	3	2	2	1	1	1	1
24 (3 Rings)	-	-	-	-	210	165	132	87	57	42	33	24	18	15	13	10	9	7	5	4	3	3	2	2	1	1
24 (4 Rings)	-	-	-	-	150	114	90	63	39	33	21	17	14	10	9	7	6	5	3	3	2	2	1	1	1	1
36 (3 Rings)	-	-	-	-	-	-	-	204	93	93	69	60	42	33	29	24	21	17	12	10	7	6	5	4	3	2
36 (4 Rings)	-	-	-	-	-	-	-	156	72	72	54	39	33	25	33	20	15	12	10	8	5	5	3	2	2	2
48 (4 Rings)	-	-	-	-	-	-	-	-	132	132	99	75	60	48	39	33	29	24	17	14	12	8	7	5	5	4
56 (4 Rings)	-	-	-	-	-	-	-	-	204	204	150	117	100	76	62	52	44	35	26	20	16	12	10	8	8	6
72 (4 Rings)	-	-	-	-	-	-	-	-	-	-	-	204	164	132	108	92	78	62	44	35	26	21	18	16	14	10
84 (4 Rings)	-	-	-	-	-	-	-	-	-	-	-	-	-	185	152	129	109	88	63	47	38	30	24	20	17	15

The above data is for using standard loading procedures. It is often possible to extend the capacity of a machine utilising special workholding arrangements and fixtures.

Conditioning Ring Spec		Machine Model										
		15	20	24	700	36	40	48	56	72	84	120
Inside Diameter (mm)	3 Rings	140	191	248	275	368	406	505	578	-	-	-
	4 Rings	-	-	209	-	322	-	432	530	692	813	1016

Kemet 15/20 Models

The bench-mounted Kemet 15 and 20 Lapping Machines have a rigid metal construction with a height-adjustable worktable. The machines incorporate a digital Process Timer and a fully automatic Liquid Diamond Dispensing System.

Features & Benefits:

- Bench mounted
- Produces optically flat surfaces with high precision surface finish
- Fully controllable Kemet Electronic Dispensing System accurately meters diamond abrasive onto the lapping plate - Reduces lapping costs
- Built-in abrasive system for conditioning Kemet Composite Plates
- Easily transportable
- Electrical System complies with EN 60 204
- Easy to adapt for special lapping applications
- Only small quantities of diamond abrasive and non-toxic fluids are used - Reduces waste

Options:

- Variable or fixed speed
- Lift-Off disc system on model 15"
- Pneumatic lift on model 20"
- aKu-Disp Peristaltic Dispenser alternative (see page 24)

Other Versions:

- Chemical polishing version (see pages 9-10 for KemCol and DiaCol)
- Clipper Blade sharpening machine



Machine Model	15	20
Lapping Plate outside Diameter	381 mm	508 mm
Lapping Plate Speed	70 rpm	70 rpm
No. of Conditioning Rings	3	3
Conditioning Ring inside Diameter	140 mm	191 mm
Max load per Conditioning ring	39 Kg	53 Kg
Height of Open Face Machine	670 mm	700 mm
Height of Pneumatic Lift Machine	N/A	965 mm
Working Height	310 mm	385 mm
Depth of Machine	660 mm	780 mm
Width of Machine	760 mm	883 mm
Standard Electrical Supply	220v-1Ph-50Hz or 380v or 415v 3Ph-50Hz*	
Main Drive Motor	0.37 kW	0.75 kW
Abrasive pump motor	0.18 kW	0.18 kW
Approx. Weight	Open Face	136 kg
	Pneumatic	N/A
		200 kg
		385 kg

Lift-Off Disc System	Machine Model 15
Aluminium Drive Plate	361002
Aluminium Lift-Off Disc	361001
Kemet Iron Lift-Off Disc	351025
Kemet Copper Lift-Off Disc	351121
Kemet XP Lift-Off Disc	351226
Kemet Tin Lift-Off Disc	351314

Recommended Consumables	Machine Model		
	15	20	
Cast Iron Lapping Plate (Lapped finish**)	Serrated	362400	362402
	Solid	362401	362403
Kemet Copper Lapping Plate	351102	351103	
Kemet Copper SP2 Lapping Plate	351159	351964	
Kemet Iron Lapping Plate	351002	351081	
Kemet PR3 Lapping Plate	351340	351374	
Kemet Tin Lapping Plate	351305	351320	
Kemet XL Lapping Plate	351356	351375	
Kemet XP Lapping Plate	351202	351266	
Dasty Industrial Degreaser (for cleaning lapping plate) - see page 28			

Recommended Accessories	Machine Model	
	15	20
Plastic Faced Conditioning Rings - Set of 3	361521	361874
Cast Iron Conditioning Rings - Serrated - Set of 3	360203	361027
Ceramic Faced Conditioning Rings - Set of 3	361522	361982
Zytel Roller Bearing Assemblies - Set of 6	360212	360212
O-rings for Zytel Bearings - Set of 6	360270	360270
Flatness Gauge	361304	

Recommended Abrasive Consumables	Code
Kemox HSR - For Plate conditioning	300195
Diamond Slurry - (see page 16 for range available)	

Huge range of other accessories and consumables available for the Kemet 15 & 20 Models

* Other voltages available upon request

** May need additional conditioning depending on application

Kemet 24/36 Models

Both Kemet 24 and 36 machines have rigid welded tubular section steel frames, supporting the gearbox, drive motor and worktable. With the option of a diamond dispensing system they also house an integral abrasive compound feed and waste tanks behind lift-off panels. The Kemet 36 machine incorporates a soft starting feature, which smoothly accelerates the Kemet Composite or cast iron lapping plate from stand still to full speed (optional extra for Kemet 24).



Features & Benefits:

- Produces optically flat surfaces with high precision surface finish
- Fully controllable Kemet Electronic Dispensing System accurately meters diamond abrasive onto the Kemet Composite Lapping Plate, reducing lapping costs and waste
- Built-in abrasive system for conditioning Kemet Composite Lapping Plates
- Suitable for large parts or large volume production
- Electrical System complies with EN 60 204

Options:

- Variable speed up to 70 rpm
- Temperature control (water cooled plates)
- 3 or 4 conditioning rings
- Col-K chemical polishing versions
- Full Perspex guarding available
- Peristaltic Slurry delivery system

Option	Open Face		Pneumatic Lift	
Machine Model	24	36	24	36
Height	920 mm	960 mm	1925 mm	1960 mm
Working Height	-	-	1150 mm	1270 mm
Width	1200 mm	1435 mm	1240 mm	1505 mm
Depth	1350 mm	1640 mm	1350 mm	1640 mm
Approx. Weight	575 kg	1165kg	700kg	1250kg
Lapping Plate outside Diameter	610 mm	914 mm	610 mm	914 mm
Lapping Plate Speed	58 rpm	58 rpm	58 rpm	58 rpm
N° of Conditioning Rings	3 or 4	3 or 4	3 or 4	3 or 4
Conditioning Ring inside Diameter	3 ring	248 mm	368 mm	248 mm
	4 ring	210 mm	322 mm	210 mm
Max load per Conditioning ring	3 ring	250 Kg	350 Kg	250 Kg
	4 ring	200 Kg	300 Kg	200 Kg
Main Drive Motor	1.5 kW	4 kW	1.5 kW	4 kW
Abrasive pump motor	0.18 kW	0.18 kW	0.18 kW	0.18 kW
Air Requirements	4 Bar min	4 Bar min	4 Bar min	4 Bar min
Standard Electrical Supply	220v or 380v or 415v 3Ph-50Hz*			

*Electronic Dispensing Equipment Standard on all above Models (see page 23)
* Other voltages available upon request*

Other Machine Models available	
Machine Model	40
Lapping Plate outside Diameter	1016 mm
Conditioning Ring inside Diameter for 3 rings	406 mm

Recommended Accessories			Machine Model	
			24	36
Conditioning Rings	Conditioning Rings Set of 3 for 3 Ring Machine	Plastic Faced	361539	**
		Cast Iron - Serrated	360208	360278
		Ceramic Faced	361528	**
Conditioning Rings	Set of 4 for 4 Ring Machine	Cast Iron - Serrated	360274	360682
		Zytel Roller Bearing Assemblies - Set of 6	360214	360259
O-rings for Zytel Bearings - Set of 6			360672	360270
Roller Bearing Assemblies - Set of 6			360213	360259
O-rings for Roller Bearings - Set of 24			-	360659
Flatness Gauge			361304	

Recommended Consumables		Machine Model	
		24	36
Cast Iron Lapping Plates (Lapped finish***)	Serrated	362404	362406
	Solid	362405	362407
Kemet Copper Lapping Plate		351106	351124
Kemet Copper SP2 Lapping Plate		351177	351965
Kemet Iron Lapping Plate		351006	351010
Kemet PR3 Lapping Plate		351357	351343
Kemet Tin Lapping Plate		351306	351315
Kemet XL Lapping Plate		351376	351377
Kemet XP Lapping Plate		351206	351227
Dasty Industrial Degreaser (for cleaning lapping plate) - see page 28			

*Huge range of other accessories and consumables available for the Kemet 24 & 36 Models
** Available on request*

**** May need additional conditioning depending on application*

Kemet 48/56 Models

These Precision Diamond Flat Lapping & Polishing Machines, are available as open face and pneumatic lift with a diamond dispensing system. Equipped with a serrated lapping plate consisting of 16 segments* for the Kemet 48 and 24 segments for the Kemet 56, the individual cast iron segments are faced with Kemet Composite material and bolted to a support plate.

* Solid plate option available for Kemet 48"

Option	Open Face		Pneumatic Lift	
	48	56	48	56
Machine Model	48	56	48	56
Height (H)	1010 mm	1030mm	2350 mm	2260 mm
Working Height (WH)	-	-	1390 mm	1400 mm
Width (W)	1510 mm	1700 mm	1510 mm	1700 mm
Depth (D)	2000 mm	2020 mm	2520 mm	2520 mm
Approx. Weight	3400 kg	4100 kg	4000 kg	5000 kg
Lapping Plate outside Diameter	1219 mm	1422 mm	1219 mm	1422 mm
Lapping Plate Speed	48 rpm	48 rpm	48 rpm	48 rpm
Conditioning Ring inside Diameter	3 ring	505 mm	505 mm	578 mm
	4 ring	432 mm	432 mm	530 mm
Max load per Conditioning ring	3 ring	375 Kg	375 Kg	400 Kg
	4 ring	325 Kg	350 Kg	350 Kg
Main Drive Motor	7.5 kW	11 kW	7.5 kW	11 kW
Abrasive pump motor	0.18 kW	0.18 kW	0.18 kW	0.18 kW
Abrasive Tank capacity	115 Litres	115 Litres	115 Litres	115 Litres
Waste tank capacity	37 Litres	37 Litres	37 Litres	37 Litres
Standard Electrical Supply	220V or 380V or 415V 3 Ph 50Hz*			

* Other voltages available upon request

Recommended Accessories	Machine Model	
	48	56
Cast Iron Conditioning Rings - Serrated for 4 Ring Machine - Set of 4	360642	*
Cast Iron Conditioning Rings - Serrated for 3 Ring Machine - Set of 3	360833	360910
Roller Bar Bearing Assembly	360729	360869
Flatness Gauge	361304	

Recommended Consumables	Machine Model		
	48	56	
Cast Iron Segments for 3 Rings - Set of 16	360265	361860	
Cast Iron Segments for 4 Rings - Set of 16	360776	362216	
Lapping Plates for 3 Rings	Kemet Iron	351161	351170
	Kemet Copper	351174	*
	Kemet Copper SP2	*	*
Lapping Plates for 4 Rings	Kemet Iron	351042	351183
	Kemet Copper	*	*
	Kemet Copper SP2	*	*
Dasty Industrial Degreaser (for cleaning lapping plate) - see page 28			

Huge range of other accessories and consumables available for the Kemet 48 & 56 Models
* Available on request

Features & Benefits:

- Higher capacity
- 3 or 4 conditioning rings
- Heavier and larger parts (up to 505 mm for Kemet 48 and 578 mm for Kemet 56)
- Water cooling option available
- Ideal for Gate Valves

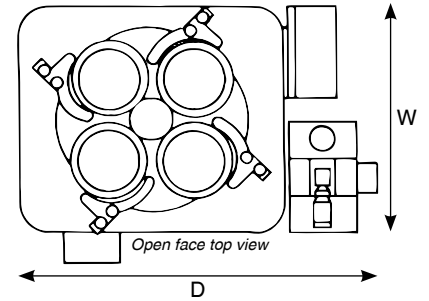
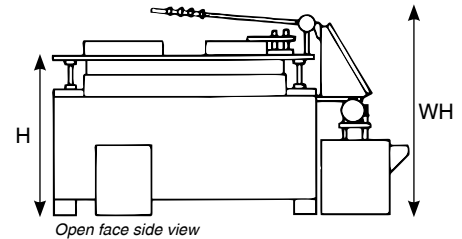

Kemet 72/84/120 Models

For larger lapping applications Kemet offer machines with a 72", 84" or 120" segmented plate, in high density cast iron or faced with Kemet composites.

Features & Benefits:

- Set within a mesh guard, a side mounted motor transmits the drive via multiple v-belts to a mechanical reduction gearbox at the centre of a cruciform shaped steel structure.
- Four stations, the roller yokes mounted on hollow section upright columns at the end of each arm, which also support the trough around the lap plate.
- Electronic soft start to smoothly accelerate the lap plate to full speed is time adjustable to suit individual process conditions.
- Suitable for use with conventional abrasive slurries or Kemet Diamond slurries.
- Electronic diamond dispenser and stirrer unit provides fully controlled metering of liquid diamond and lubricating fluid to each station, via dispensing bars and spray heads, to ensure even distribution and minimise consumable costs and waste.
- Free-standing conventional abrasive reservoir/stirrer/pump supplies four individually adjustable feeds to each of the stations.
- Water cooling option available



Open Face Version

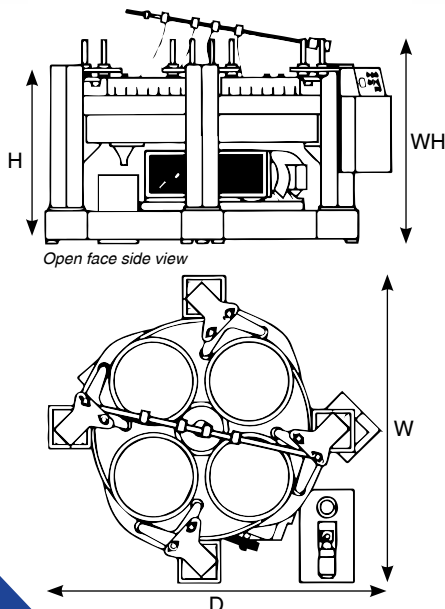

Option	Open Face			Pneumatic Lift		
	72	84	120	72	84	120
Machine Model	72	84	120	72	84	120
Approx. Height (H)	1350 mm	1500 mm	*	2764 mm	*	*
Working Height (WH)	-	-	-	*	*	*
Approx. Width (W)	3026 mm	2600 mm	*	3026 mm	2600 mm	*
Approx. Depth (D)	3073 mm	2600 mm	*	3073 mm	2600 mm	*
Approx. Weight	6000 kg	9000 kg	*	10000 kg	12000 kg	*
Lapping Plate outside Ø	1829 mm	2134 mm	3000 mm	1829 mm	2134 mm	3000 mm
Approx. Lapping Plate Speed	30 rpm	20 rpm	18 rpm	36 rpm	20 rpm	18 rpm
No. of Conditioning Rings	4	4	4	4	4	4
Conditioning Ring inside Ø	692 mm	813 mm	1025 mm	692 mm	813 mm	1025 mm
Max load per Conditioning ring	2000 Kg	2250 Kg	*	2000 Kg	2250 Kg	*
Main Drive Motor	15 kW	30 kW	*	15 kW	30 kW	*
Abrasive pump motor	0.18 kW	0.18 kW	0.18 kW	0.18 kW	0.18 kW	0.18 kW
Abrasive Tank capacity	117 Litres	117 Litres	132 Litres	117 Litres	117 Litres	132 Litres
Waste tank capacity	37 Litres	37 Litres	57 Litres	37 Litres	37 Litres	57 Litres
Standard Electrical Supply	220V or 380V or 415V 3 Ph 50Hz**					

* Designed to customer specification
** Other voltages available upon request

KemiSphere II - Bench Top Spherical Lapping Machine

The Kemisphere II is a small single station spherical lapping and polishing machine ideal for either matching 2 spherical forms together or, with appropriate tooling, has the ability to lap and polish spherical forms to better than 5µm roundness with a mirror finish. It's a perfect replacement for jobs currently hand lapped together, and its bench top design makes it a useful addition to any workshop involved in spherical lapping.

Features & Benefits:

- 3 motors with independent variable speed control
- Siemens PLC and HMI
- Pressure application system
- Benchtop machine
- Process parts up to 100mm diameter
- Programmable sweep start and finish point
- Single button process start
- Manual and jog facility for simple machine setting
- CE marked
- Fully guarded with interlocks
- Dimensions: 906 x 1055 x 549mm
- 230V-single phase-50Hz
- Product code: 359316



Kemet Spherical Lapping Machine

The Kemet Spherical Lapping Machine laps and polishes pre-machined spherical balls and cups to a mirror finish with the capability of achieving roundness better than <3 microns.

Features & Benefits:

- 6 motors all with independent variable speed to provide complete control
- Size: 1600 (W) x 820 (D) x 2500 (H) mm
- Lapping and polishing pressures applied pneumatically
- Average process time less than 5 mins
- Simple change from ball to cup polishing action
- Manual and jog facility provided for setting up
- Fully guarded with auto lifting door access
- Comes complete with initial tooling set
- Full manual and training provided
- Low running costs
- Dual process timers
- Single button process start
- Lighting provided
- Smooth and silent running
- CE marked. Electrical supply 230V-single phase-50Hz or 110V-single phase-60Hz
- Air: 3 bar max
- Product code: 360061



KemTech SpheriMatch II - Match Lapping Machine

The KemTech SpheriMatch II provides an automated method to match lap two valve halves, or similar components, together: For example - matching the concave barrel of a hydraulic piston pump to its convex swash plate. These faces need a perfectly matching radius to maintain performance and minimise leakage.

The SpheriMatch enables the removal of even deep scoring and final match lapping of bodies up to 300mm tall and ranging from 75mm up to 250mm diameter.



4 versions of the SpheriMatch II are available:

SpheriMatch II:

- 250mm diameter chuck with variable speed
- Servo controlled sweep arm with programmable start finish points
- Cantilevered pressure weight system (as per existing machine)
- Dimensions: HxWxD (1022 x 862 550mm)
- 4.3" Unitronic HMI & PLC
- Product Code: 359005

SpheriMatch II+:

- As SpheriMatch II but with:
- Abrasive stirrer
- WM FD114 Peristaltic Pump
- Product Code: 359006

SpheriMatch II Driven:

- As SpheriMatch II but with Driven head
- Product Code: 359008

SpheriMatch II+ Driven:

- As SpheriMatch II+ but with Driven head
- Product Code: 359007

With a fully programmable process timer, this versatile machine can match lap curved or flat surfaces, of the same or different materials, with variable rotation speeds up to 70 rpm and a range of sweep arm strokes and speeds to suit the components being lapped.

Used in combination with Kemet's diamond compounds and conventional aluminium oxide pastes, the Spherimatch is an essential tool for any hydraulic servicing centre.

Kemet offer trials complete with a full test report showing process times and stages for each pair of parts.



Match lapped 125mm piston pump body and swash plate

One component part is held in a fully guarded, three jaw chuck with reversible jaws and the opposing part located under the sweep arm with a specially designed location and anti-rotation fixture. Pressure is applied to the top part being lapped.

Kemet 300L2 - Small Lapping Machine

The smallest of our range of lapping machines, the benchtop mounted Kemet 300L2 is fitted with a 300 mm lapping plate, driven by a high torque variable speed motor. Depending on the application, the machine can be fitted with either a serrated cast iron plate or a choice of one of Kemet's composite plates to suit the application.

A single control ring, with an OD of 140mm and ID of 125mm, located in a ring style holder, runs between 3 rollers and is adjustable for both height and position.

Options		Product Code
Handweight (123mm diameter)		345450
Conditioning ring, 140mm OD x 125mm ID x 40mm height		345434
Plastic faced conditioning ring		345454
	Aluminium	345537
Lift-Off Disc (300mm diameter)	Kemet Iron	351415
	Kemet Copper	351414
	Kemet Copper SP2	351411
Cast Iron Plate	Solid	351413
	Serrated	351412
Electrical requirements	220V-1Ph-50Hz	345347
	110V-1Ph-60Hz	345347A

Specification

- 300mm diameter plate
- High Torque Motor (1 HP)
- Variable speed ranges 50 - 100rpm
- Digital Timer 0 - 99 mins
- Dimensions 450 x 800 x 400mm
- Weight 42 Kg



Twin Lap - Dual Face Lapping

The Kemet Twin Lap M machine is a small but versatile bench mounted machine ideally suited for small workshops and laboratories for double sided lapping (Twin Lap L is a floor standing machine). It comes fully equipped and ready to use and is suitable for lapping components up to 114mm diameter and up to 30mm thick. In certain circumstances, larger components can be accommodated.

As with all double sided lapping machines, we recommend that the lap plates are re-conditioned using conditioning gears on a regular basis. The machine can also be fitted with diamond dispensing equipment and special complementary lap plates. Automatic thickness control is also an option.



Technical Specifications	Twin Lap M	Twin Lap L
Height (mm)	630	1580
Depth (mm)	780	800
Width (mm)	770	770
Capacity	Ø51mm OD max component size, 20mm thick max. Ø114mm OD max component size, 30mm thick max. Thickness +/- 0.005mm. Flatness <0.0005mm	
Maximum plate force	5Kg	20Kg
Outer ring gear speed	0 - 111 rpm 60W DC drive	0 - 26 rpm 300W DC drive
Inner sun gear speed	0 - 125 rpm 60W DC drive	0 - 64 rpm 300W DC drive
Approx. Weight	80kg	300Kg
Standard Tooling	One Cast iron lap plate Ø175mm	One Cast iron lap plate Ø370mm
	One set cast iron conditioning gears, One set top plate weights, One set work carriers	
Optional Tooling	<ul style="list-style-type: none"> • Stainless steel backing plates • Polishing pads • Conditioning brushes 	
Optional Features	<ul style="list-style-type: none"> • Electronic thickness control • Stainless steel 316 parts for corrosion resistant processing 	
Electrical supply	230V-single phase-50Hz or 110V-single phase-60Hz	
Product code	359314	

KemTech III Thin Section Lapping Machine

The KemTech III Thin Section Lapping Machine is able to accurately lap and polish thin sections mounted on glass slides down to 20 microns. Metered dosing of conventional and/or diamond abrasives is applied to the lapping plate using the integrated peristaltic dispenser. The Kemet Lift-Off Disc system allows quick transitions between the lapping and polishing stages.

Features & Benefits:

- Driven rings, for faster processing times (2 included with machine as standard, 3rd an optional extra)
- Sealed, maintenance free, reduction gearbox
- Connectors to suit Kemet vacuum jigs, which are available as an optional extra
- Integrated abrasive tank with stirrer
- Accurate peristaltic dispensing system for metered dosing
- Capacity for up to 3 vacuum jigs
- Variable Speed up to 70 rpm
- Stand-alone vacuum pump
- 4.3" HMI Touchscreen
- Water trap and filter
- Aluminium LOD for Polishing
- Cast Iron serrated LOD for Lapping

Also available in 20" with guarding

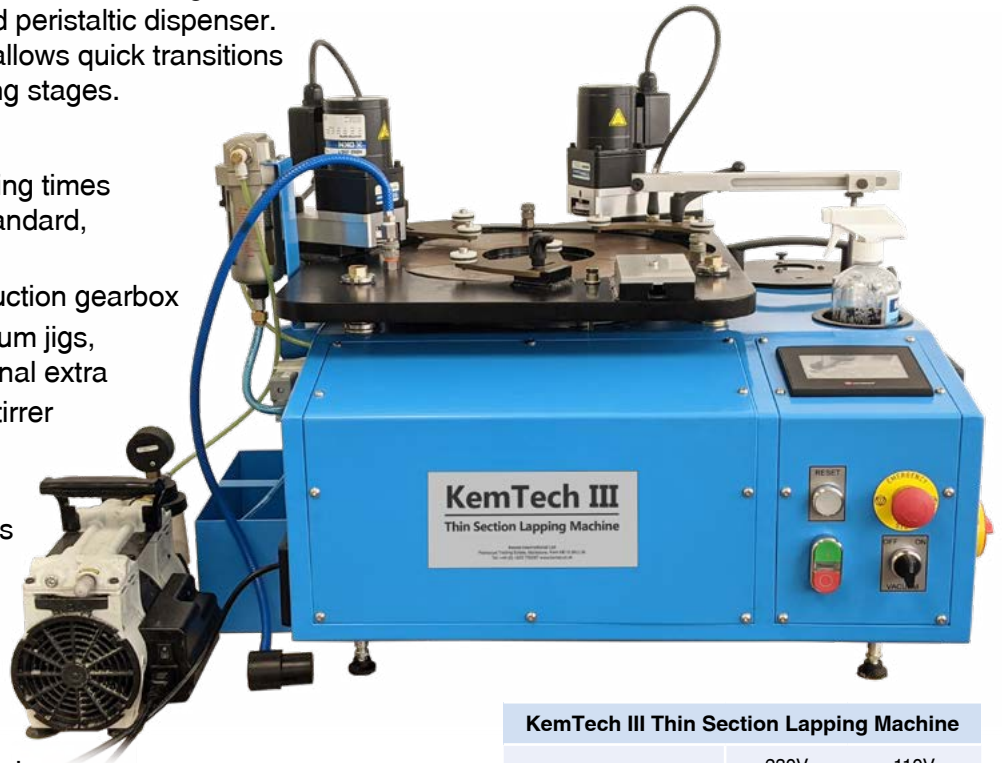

KemTech III Thin Section Lapping Machine

Voltage	230V	110V
	1ph - 50/60hz	
Product code	359842	359842A

Kemet DiaCol - Lapping / Polishing / Super Finishing Machine

The Kemet DiaCol has been developed as a versatile machine that is able to lap and polish components using the complete range of processes from conventional lapping with a cast iron plate and aluminium oxide or silicon carbide slurries, precision diamond lapping and polishing with a Kemet composite lapping plate and Kemet's diamond slurries and super finishing CMP (Chemo Mechanical polishing) using a CHEM-H pad and Col-K polishing media. Machine available in 15", 20" and 24".



Features & Benefits:

- Stainless Steel adjustable worktable, conditioning ring, roller bearing assemblies and pressure weights
- Epoxy coated support plate
- Conventional abrasive system
- Kemet Diamond dispensing system and stirrer
- Ceramic faced or stainless steel conditioning rings for contamination free polishing
- Kemet AkuDisp fully programmable peristaltic pump unit fitted as standard
- Suitable for Kemet magnetic polishing pad system for easy pad change

Product	Code
Kemet DiaCol 15	359867
Kemet DiaCol 20	359859
Kemet DiaCol 24	359869

KemCol - Super Finishing Machines - 15" / 20" / 24"

The KemCol Super Finishing machines are based on the popular Kemet range of lapping and polishing machines, but incorporate stainless steel elements in place of painted components for longer life, and contamination free polishing. They come as standard with an integrated Kemet aKu-Disp fully programmable peristaltic pump system, and either ceramic faced, or stainless steel conditioning rings. The machines are ideal for chemo mechanical polishing and Cerium Oxide based polishing applications. Cerium oxide suspensions and powders are available upon request.

Features & Benefits:

- Stainless steel drive plate
- Ceramic faced or stainless steel conditioning rings for contamination free polishing
- aKu-Disp fully programmable peristaltic pump unit fitted as standard
- Aluminium lift-Off disc system optional
- Stainless steel worktable surrounding polishing pad
- Suitable for Kemet magnetic polishing pad system for easy pad change
- Polished stainless steel yokes for easier cleaning



Machine Model	15	20	24
Height (mm)	400	700	920
Working Height (mm)	310	385	-
Width (mm)	800	883	1200
Depth (mm)	650	780	1350
Nett Weight (kgs)	90	200	575
Polishing Pad Diameter (mm)	380	508	610
No of conditioning rings	3	3	3 or 4
Inside diameter of conditioning rings (mm)	140	191	248
Main Motor (kW)	0.37	0.75	1.5
Product code	359876	359872	*



Titanium medical device polished with Col-K (X)

Automated & Bespoke Lapping Machines

As well as these standard flat, spherical, match lapping machines, Kemet also offer a bespoke machine manufacturing service for applications where an off the shelf system is not available. This can be as basic as converting a hand finishing operation to an automated process, or as complex as a conveyor fed single piece lapping system capable of producing a finished part every 9 seconds. No application is too small for consideration.





Model FL - Suitable for valves with flat Seats Ø 50 - 300 mm (2" - 12")

- Individually driven grinding heads for perfectly flat seats
- Gives you an absolutely flat sealing surface
- Air drive unit as standard 6 - 7 bar
- Electric drive unit available
- Variable grinding speed on all drive units
- Supplied with a mounting plate for grinding discs and wedges
- Heavy duty carrying/storage case for the complete machine with all the necessary accessories

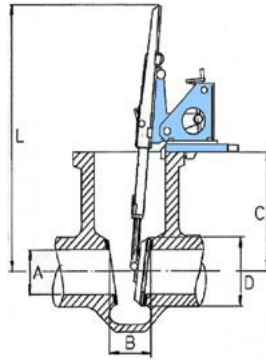

Possible range for model FL:

A:	50 - 300 mm (2" - 12")
B:	39 mm (1.56") min
C:	100 mm (4") min 600 mm (24") standard 1000 mm (60") max (option)
D:	80 - 357 mm (3.20" - 14.8")
L:	570 mm (22.8") min
Carrying case: 760 x 560 x 280mm (30.4" x 22.4" x 11.2")	
Total weight: 39 kg (87.8 lb)	

Model K & K Universal - Suitable for valves with flat seats Ø 8 - 150 mm (1/4" - 6") and/or angled seats Ø 8 - 65 mm (1/4" - 2 1/2")

- Guiding plates for a more precise grinding
- Available with compressed air drive unit (6 - 7 bar), electric battery drive unit or electric 110/220 V drive unit
- All drive units are reversible and have variable grinding speed
- Extended grinding plates and Diamond grinding discs available
- Self adhesive grinding discs for quick attachment to the grinding plates and cones

Possible range for model K:

A Min:	8 mm	E:	30 (2 x 15)
A Max:	150 mm	E:	40 (2 x 20)
B Min:	18 mm	E:	60 (2 x 30)
B Max:	170 mm	E:	75 (2 x 37.5)
C Min:	80 mm	E:	90 (2 x 45)
C Max:	280 mm		
D Min:	20 mm		
Carrying case: 530 x 400 x 240 mm			
Total weight: 20 kg (42 lb)			

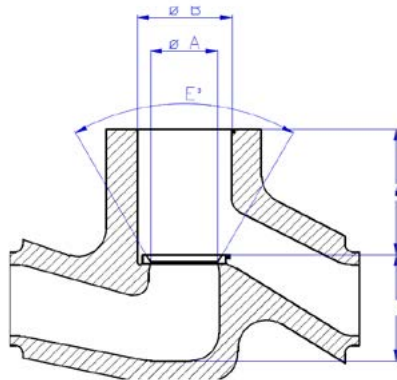

**For more information on our
'Portable Valve Grinding
Machine' range, please
request a catalogue**

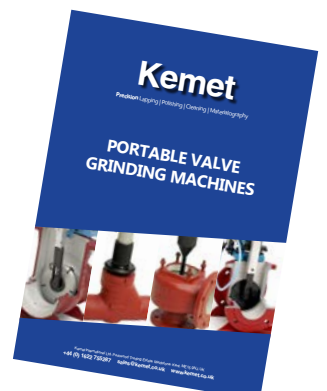

Model G - Suitable for valves with flat seats \varnothing 150 - 1300 mm (6" - 52")

- Individually driven grinding heads for an absolute flat sealing surface
- The driving heads have diametrically adjustable grinding heads
- Tilting the driving head gives the flexibility to grind both gate and globe valves with the same drive unit
- Air drive unit as standard 6 - 7 bar
- Electric drive unit available as an alternative
- Variable grinding speed on all drive units
- Self-adhesive grinding discs for quick attachment to the grinding heads
- Heavy duty carrying/storage case for the complete machine with all the necessary accessories
- Self-adhesive grinding discs 40 to 1000 grit available
- Diamond grinding discs available
- Adaptor plates for wider seats available
- Thin section driving heads available
- Grinding heads for angled seats available

Possible range for Model G:

A: 150 - 1300 mm (6" - 52")

B: 68 mm (2.72") min

C: 100 mm (4") min

900 mm (36") standard

1500 mm (60") max (option)

D: 150 - 1371 mm (6" - 54.8")

L: 730 mm (29.2") min

Carrying case: 960 x 520 x 380 mm
(15.2" x 20.8" x 38.4")

Total weight: 67 kg (148 lb)

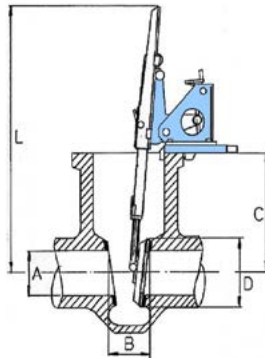

Valve Grinding Consumables

The efficiency of the machine relies on the grinding discs used. The wrong discs will either slow you down drastically or in worst case damage the valve. The grinding discs are specially designed for valve grinding. They have been proven in our facilities and out on the field. To make you sure that you get the best out of your machine, we have a wide selection of grinding discs from 40 grit down to 3 microns with diameter sizes from 17 - 70mm.



Grinding Accessories

Grinding accessories are available to suit all models. These include Cast iron and diamond faced discs including special angled discs.



Lapping Consumables

Kemet Composite Lapping Plates

Manufactured from a homogeneous mixture of synthetic resins and metal particles, the plates are designed for Kemet's advanced lapping technology, perfectly compatible with Kemet's extensive range of Liquid Diamonds.

Benefits

- Holds diamond particles firmly, ensuring both efficient stock removal and repeatable component surface finish
- Ductile qualities cushion the diamond particles, preventing damage to the workpiece
- Produced in varying hardness values so that even the softest material can be safely lapped with diamond particles without the fear of impregnation
- Easy control for optimum flatness
- Lapping/polishing plates available to fit all makes of lapping machines with plate diameters up to 3000mm
- Recommended when high precision flatness and surface finish are required
- Dissipates heat and prevents laminar flow of lapped surfaces
- Supplied with a cast iron backing plate for maximum stability

Composite Material	Plate Diameter (inches)			
	15	20	24	36
Kemet Iron	351002	351081	351006	351010
Kemet Copper	351102	351103	351106	351124
Kemet Copper SP2	351159	351964	351177	351965
Kemet XP	351202	351266	351206	351227
Kemet PR3	351340	351374	351357	351343
Kemet Tin	351305	351320	351306	351315
Kemet XL	351356	351375	351376	351377

Custom sizes and grooving are available

Composite Material	Description
Kemet Iron	The most commonly used plate. For general purpose stock removal and lapping operations
Kemet Copper	Used to lap softer materials where fine lapping and polishing are the primary requirements
Kemet Copper SP2	Can be used for lapping and/or polishing hard and medium hardness materials
Kemet XP	Gives improved flat polished surfaces on many materials. Flat mirror-like surfaces can be produced on many hard materials
Kemet PR3	Used to generate highly reflective surface finish. Ideal for pre-pad polishing for minimum roll off
Kemet Tin	One of the softest Kemet Plates used for mirror polishing with fine grades of Kemet Liquid Diamond
Kemet XL	Replacement for Lead/Tin plate, used for mirror polishing

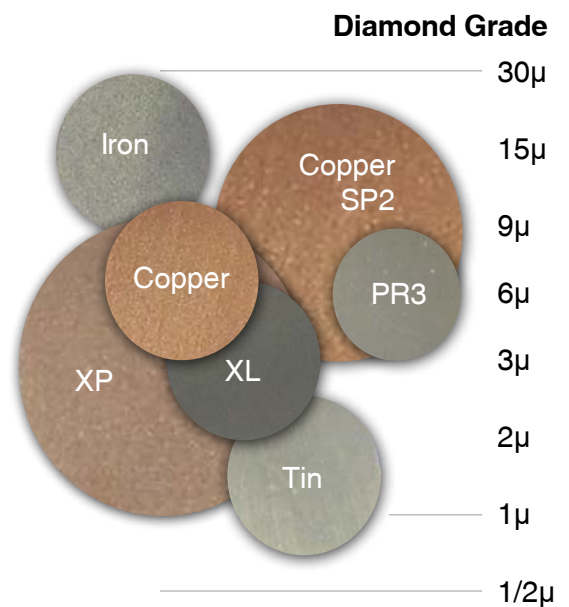

Kemet Composite Lapping Rods

For use with Kemet's diamond compounds, Kemet composite rods are manufactured from a homogeneous mix of synthetic resins, metal particles and other materials. Produced in a variety of hardness values, the softest materials can be safely lapped with Kemet Diamond compound. They are commonly used to improve the surface quality of parts following lapping with Kemet Helilaps.

Type	Diameter Size (mm)		
	25x150	50x150	75x150
Kemet Iron	352101	352102	352103
Kemet Copper	352104	352105	352106
Kemet XP	352113	352108	352114
Kemet Tin	352107	352116	352163



Cast Iron Lapping Plates / Segments

Kemet offer a wide range of cast iron lapping plates and segments to suit most lapping machines.

Cast Iron Lapping Plates (Lapped finish**)	Plate Diameter (inches)			
	15	20	24	36
Serrated	362400	362402	362404	362406
Solid	362401	362403	362405	362407

* Other sizes available on request

** May need additional conditioning depending on application



Lift-Off Disc System

Suitable for multistage processing when workshop space is a premium or budget constraints only allow a single machine. Kemet Lapping Plates are available as Lift-Off Discs 300mm or 15" diameter. Discs are supplied mounted on an aluminium backing plate, which locates onto an aluminium drive plate by means of three pegs. Lift-Off Discs can be easily changed and are recommended for light duty work where general flatness and precision finish are required.

Description	300mm	15"
Aluminium Drive Plate	-	361002
Aluminium Lift-Off Disc	345114	361001
Kemet Iron Lift-Off Disc	351303	351025
Kemet Copper Lift-Off Disc	345117	351121
Kemet Copper SP2 Lift-Off Disc	351381	362276
Kemet XP Lift-Off Disc	351219	351226
Kemet Tin Lift-Off Disc	-	351314

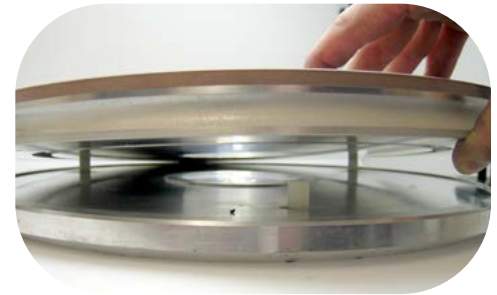

Lapping Plate Grooving

Lapping plates can be supplied grooved to suit specific applications. A cross hatched pattern is common on Cast Iron Hand Lapping plates and Dual Face Machine plates and gives increased stock removal rates due to increased surface pressure and the additional cutting edges generated on each groove. A Spiral groove pattern is used primarily when polishing parts that need to have a good surface finish and flatness, allowing contamination to be carried away from the cutting surface and making it easier to keep the lapping plate contact surface flat. The edges of the groove maintain good stock removal even though the diamond particle size may be small.

Annular Grooved Plates

These plates are designed for precision shoulder lapping of a wide range of parts, such as fuel pump gear faces and pressure relief valve caps. These are bespoke manufactured and the groove width and depth of plates need to be specified when ordering.

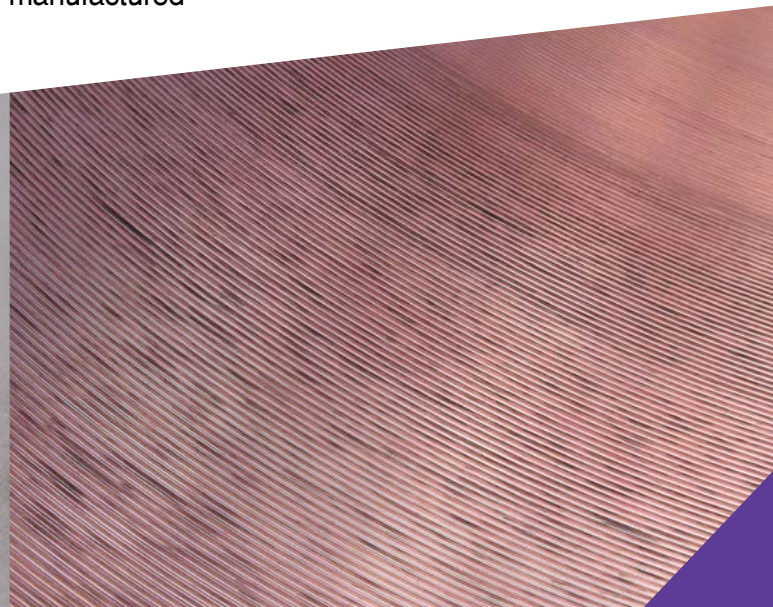
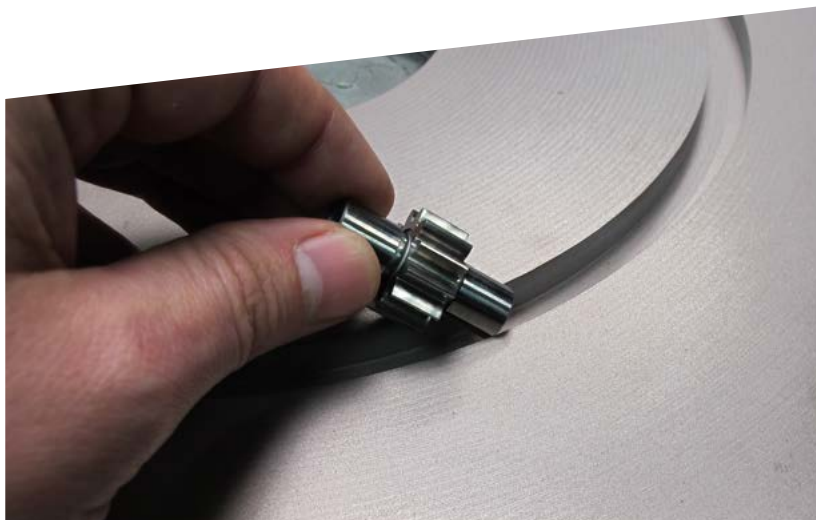

Cast Iron Hand Lapping Plates



The Cast Iron plates are made from high quality, low porosity grey cast iron (Grade 300 to BS1452). These are used with an abrasive grit, applied in paste form to give a uniform dull matt finish on a wide variety of metallic and non-metallic materials. Other sizes available.

Hand Lap Plate	Disc Diameter									
	2"	3"	4"	6"	8"	10"	12"	18"	20"	24"
c/hatch grooves		-	-	361021	360835	360830	360198	360707	362516	361029
Solid	361733	361797	361736	361738	361739	361997	360264	360762	-	361193
Hand Lap Plate	Square (WxLxH) 12" x 12" x 2"									
c/hatch grooves	362473									



Soft Metal Hand Lapping Plates

The Soft Metal plates are made of Tin.

Description	6"	12"
Hand Lap Plate SOFT METAL	361049	361046

Conditioning Rings

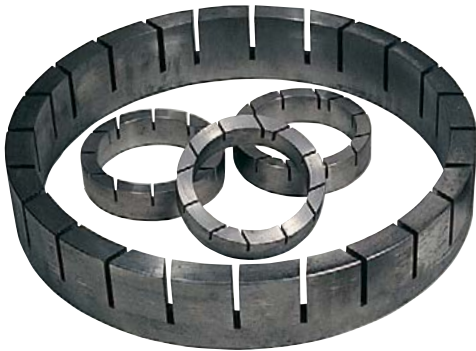

Cast Iron Conditioning Rings available as solid or serrated. Replacements are available to fit most flat lapping machine models.

Plastic faced and ceramic faced conditioning rings are also available and these are used for polishing rather than lapping operations.

Lapping Machine	Cast Iron Serrated		Plastic Faced	Ceramic Faced
	3 Ring	4 Ring		
Kemet300L2	-	-	345454	-
Kemet 15	360203	-	361399	361522
Kemet 20	361027	-	362736	361982
Kemet 24	360208	360274	361665	361528
Kemet 36	360278	360682	361981	*
Kemet 40	360683	*	-	-
Kemet 48	360833	360642	-	-

* Available on request

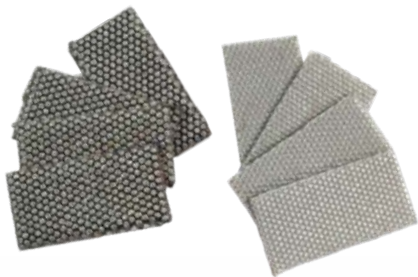

Dressing Pads

Kemet Diamond Dressing Pads come in two different varieties - coarse and fine. They are self adhesive and are fixed to the bottom of cast iron conditioning ring for rapid plate flatness correction on Kemet Lapping Machines.

Grade	Unit	Code
Fine	Pack of 8	361524
Coarse	Pack of 8	361525
Fine	Pack of 12	361526
Coarse	Pack of 12	361527



Diamond Dressing Ring

For rapid correction of Kemet Composite Lapping Plates, particularly when convex, the Diamond Dressing Ring is supplied with Grit 80 diamond pellets bonded to a cast iron conditioning ring.

Lapping Machine	Dressing Ring
Kemet 15	362677
Kemet 24	362678
Kemet 36	362668

The Diamond Dressing Ring has proven to be significantly faster than using traditional materials.

Liquid Diamond

Our range of Kemet Liquid Diamond products are available as oil soluble, water soluble or as emulsions. The chemical composition of the carrier fluids is carefully controlled to ensure that they are compatible both with the Kemet Lapping Plate and the components being lapped.

- Precision graded diamond particles in a fluid
- Optimum viscosity and chemical composition of each Liquid Diamond Product gives fast stock removal with the ability to produce superfine surface finishes
- Specially formulated Liquid Diamond Products enable parts to be easily cleaned
- Suitable for dispensing with the Kemet Electronic Dispensing System and aKu-Disp thus eliminating wastage and reducing lapping costs



LIQUID DIAMOND

Micron	TYPE K (Oil / water emulsion) An excellent, low viscosity oil/water emulsion suitable for all general purpose lapping						TYPE O (Oil based) An excellent, general purpose, low viscosity oil based suspension suitable for heavy parts and high volumes						
	400g			2000g			400g			2000g			
	Standard	Strong	Extra Strong	Standard	Strong	Extra Strong	Standard	Strong	Extra Strong	Standard	Strong	Extra Strong	
A	1	211004	211024	-	211084	211105	-	216004	216024	-	216085	216104	-
	2	211005	211025	-	-	-	-	216005	216025	216045	216081	216105	216136
	3	211006	211026	211046	211086	211106	211126	216006	216026	216046	216086	216106	216137
	4.5	211007	211027	211047	211087	211107	211127	216007	216027	216047	216087	216108	216138
B	6	211008	211028	211054	211088	211108	211128	216008	216028	216048	216088	216107	216139
	8	211009	211029	-	211089	211109	211129	216009	216029	216049	216089	216109	216140
	10	211010	211030	211050	211085	211110	211130	216016	216030	216050	216095	216110	216141
C	14	211011	211031	211051	211091	211111	211131	216011	216031	216051	216092	216111	216142
	25	211012	211032	211052	211092	211112	211133	216012	216032	216052	216090	216112	216143
	45	211013	211033	211053	-	-	-	216013	216033	216053	216094	216113	216144

A = Final Polishing B = Lapping & Pre-polishing C = Rapid Stock Removal

Other micron grades available on request

FastCut

FastCut offers a water based version that, in tests, has exceeded the performance of oil based products by as much as 25%.

- Excellent stock removal
- Easy to clean & non-foaming
- Lubricating Fluid Type W9 recommended with FastCut

Micron	FastCut	
	400g	2000g
1	219416	219417
3	219418	219419
6	219420	219421
8	219422	219423
14	219424	219425
25	219426	219427



OptiPol

OptiPol is a water soluble, high concentration slurry using polycrystalline diamond powder. These slurries are excellent for silicon carbide, carbon and tungsten carbide "gas seals", where a mirror finish, with a 3 light band convex flatness is required without the need to touch-up with a polishing pad process.

Micron	OptiPol	
	400g	2000g
0.1	250650	250654
1	250651	250655
3	250652	250656

* ZERQ Volatile Organic Compounds (VOC) - not classified as an atmospheric pollutant and offer health and safety benefits. VOCs are organic chemicals that have a high vapour pressure at ordinary room temperature, some of which can be dangerous to human health and/or cause harm to the environment.



Lubricating Fluids

- Assists Kemet Diamond Products to cut and polish more effectively by absorbing frictional heat and diluting the lapping residue.
- Lubricant performance remains stable even when under high pressure.
- Manufactured from high purity chemicals.

Type	 *	Description	Soluble in	Colour	450ml Trigger spray	2.5 Litres	25 Litres
W	Yes	Recommended for use on all Kemet Polishing Cloths as it helps to extend their life	Water	Clear	301201	301101	301151
W9	Yes	Recommended for use with FastCut Liquid Diamond & AquaPol	Water	Clear	301533	301527	301530
W2		Developed for use with Kemet Diamond Suspension, particularly when used with Kemet Lapping Plates.	Water	Clear	301202	301102	301205
GW2			Water	Light green	301514	301108	*
Blue		Improves cutting and polishing performance on cloths or plates	Water	Blue	301200	301156	*
LS		Where components need to undergo a water based cleaning operation after lapping	Oil/Water	Blue	301204	301104	*
K	Yes	Assists smooth running of the lapping operation and helps to ensure a cleaner process	Oil	Clear	301178	301124	301125
R OS2		For use where water is not permitted	Oil	Red	301513	301512	*
OS	Yes	Recommended when polishing tooling, moulds and similar components	Oil	Blue	301203	301103	301112

* Available on request

Kemox - Abrasive Slurry

Kemox is a conventional lapping abrasive that has been suspension treated so that the abrasive particles do not settle out into a hard sediment in the bottom of the abrasive tank. Kemox is available in water soluble (Kemox-W) or oil soluble (Kemox-O) formulations in 5 or 20 Litres. The abrasive concentration is always correct and eliminates the health and safety risk of adding powder to oil.



Product	5 Litres	Description	Product	5 Litres	Description
Kemox O-960	300101	Oil Based. Finest surface finish on soft components	Kemox O-400	300105	Oil Based. Plate conditioning and matt lapping where good stock removal and a matt lap is required
			Kemox O-400S	300111	
Kemox O-950	300102	Oil Based. Finer surface finish on soft components	Kemox HSR	300195	Oil Based. Faster stock removal for plate reconditioning
Kemox O-900	300103				
Kemox O-800	300104	Oil Based. General aluminium oxide lapping where a scratch free matt lap is required	Kemox W-800	300143	Water based
Kemox O-800S	300112		Kemox W-400	300141	
Kemox O-800 (Fine)	300107		Water based where oil can't be used. Finer surface finish on soft components	Kemox W-950	300152
Kemox O-800 FHC	300109				
				Kemox W-2800 (SiC)	300131

Kemox SF - Aluminium Oxide Treated Suspension

Benefits

- Extremely strict selection process for particle size, shape and hardness to ensure maximum polishing performance over an extended life cycle
- Superior surface finish & excellent stock removal rate
- Easy clean up and Long life
- Low viscosity to promote improved flow for polishing materials

Size	Code
5 Litre	300199
3.8 litres	300200
1 Litres	300207



Col-K - Colloidal Silica Suspension

A Liquid polish used on Kemet Chem Cloth to produce the ultimate in high quality mirror polishes on polishing machines. A part abrasive, part chemical polishing action makes **Col-K** well suited to polishing difficult materials such as Stellite and Cobalt Chrome. **Col-K(X)** has been specially developed to mirror polish Titanium without the need for any chemical additives. **Col-K (NC)** is a non-crystallising version.

Product	Size		
	1 Litre	5 Litres	20 Litres
Col-K	600262	600212	600204
Col-K (NC)	600261	600199	600202
Col-K (X)	*	600267	*

* Available on request



Lapping Pastes & Powders

Kemet manufacture a wide range of abrasive lapping pastes. Our range of Silicon Carbide and Aluminium Oxide pastes have many applications but are particularly suited to the lapping of mechanical seals and valve seats. The pastes are **water soluble** and safe to use.

Product	Type	Micron	FEPA Grade	Powders		Product	Type	Micron	FEPA Grade	Pastes
				5 kg	25kg					1kg
Green Silicon Carbide	Fine	3	1200	361537	361616	Silicon Carbide	Fine	3	1200	361547
		5	1000	361535	361536			5	1000	361552
	Medium	9	600	361563	361631		Medium	7	800	362616
		17	400	361512	361579			9	600	361514
		Coarse	37	280	361532			361629	17	400
75	180		361541	361653	23	360	361548			
Black Silicon Carbide	Medium	9	600	361562	361651	Aluminium Oxide	Coarse	30	320	361558
		22.8	360	361648	361649			37	280	361538
	Coarse	37	280	361646	361647		75	180	361549	
		53	230	361644	361645		109	120	361689	
Aluminium Oxide	Medium	7	800	361676	361615	Aluminium Oxide	Fine	3	1200	361544
		9	600	361555	361614			5	1000	361624
	Coarse	23	360	361554	361561		7	800	361545	
						Medium		9	600	361543
								13	500	361546
						Coarse		23	360	361542



Universal Lapping Oil

Lubrication is necessary for a smooth running condition between the lap plate and conditioning rings and to help evenly disperse the abrasive product on the lap plate. The Lapping vehicle used with any abrasive powder should be properly matched in order to give the best cutting action possible, maintain even dispersion of abrasive throughout the lapping surface, and produce uniform finishes. The proper lapping vehicle in conjunction with the right abrasive will reduce lapping time and reduce the amount of slurry needed to complete the job. A typical mix would be 1kg of abrasive to 5 Litres of lapping oil.

Size	Code
5 Litres	361516
25 Litres	361517
205 Litres	361498



* ZERO Volatile Organic Compounds (VOC) - not classified as an atmospheric pollutant and offer health and safety benefits. VOCs are organic chemicals that have a high vapour pressure at ordinary room temperature, some of which can be dangerous to human health and/or cause harm to the environment.



Diamond Compound / Paste

For hand lapping and spherical polishing applications, Kemet offers a huge range of Diamond Compounds for rapid stock removal, superfine surface finish, lapping and pre-polishing. From 1/10 to 90 micron. Soluble in either oil (**Type L**), water (**Type W**) or both (**Type KD**). High thermal stability of the chemical carrier ensures that Kemet Diamond Compound resists frictional heat, remains stable, and keeps its suspension properties under operating conditions. **DiaVers** Diamond Paste has been specially formulated to give fast stock removal and at the same time a superior surface finish. **XtraPol** has been specially developed to polish aluminium.

For our full range of Diamond Compounds, please view our [website](#) or diamond catalogue (available on request).

Micron	Colour	DiaVers		
		5g Applikator	10g Syringe	20g Syringe
1	Blue	115558	115541	115548
3	Green	115507	115542	115549
6	Yellow	115508	115543	115550
8	Red	115559	115544	115551
14	Brown	115560	115545	115552
25	Colourless	115561	115546	115553
45	Colourless	115562	115557	115555
60	Colourless	115563	115547	115554

Diamond Stick

Water soluble diamond compound applicator stick, manufactured from Polycrystalline or Monocrystalline Diamond Powder.

- Eliminating the need of spatulas for easy application
- Supplied in 10g Applicator Stick

Micron	Monocrystalline	Polycrystalline
1	113189	113201
3	113190	113202
6	113191	113203
8	113192	113204
14	113193	113205

Sabre Aluminium Oxide Paste

Specially formulated containing Aluminium Oxide Abrasive and is available in 20g syringes. It is suitable for a wide range of lapping/polishing operations, and it is particularly effective when used for smoothing soft metals such as brass, aluminium and copper. It is also effective for smoothing small areas of glass prior to polishing. Sabre Pastes are also available based on both silicon carbide and boron carbide abrasives.

Micron	Code
0.1	300206
0.5	300205
3	300204
7	300203
9	300202
23	300201

Aluminium Oxide Lapping Film

Tightly graded aluminium oxide coated onto a 0.3mm thickness polyester film backing. Available with or without PSA (pressure sensitive adhesive).

- Excellent surface finish
- Reduces overall process time
- Produces high yields
- Non-slurry processing

Micron	Colour	Code
0.3	White	361706
1	Green	361707
3	Pink	361708
5	Brown	362420
9	Blue	361709
12	Yellow	361710
30	Green	361711
40	Blue	361712
60	White	361713

216 x 280 mm sheet plain backed Aluminium Oxide Lapping Film - Supplied in packs of 50

Diamond Lapping Film

Kemet precision coated diamond abrasive lapping film products are specifically engineered to meet all your ultra-fine, consistent polishing and final finishing requirements.

- Wide range of engineered, tightly-graded micron-sized particles. Ensures consistent, long-lasting polishing. Generates scratch free surfaces; achieving Ra values under 1 micro-inch on hard materials, including HVOF depositions. Improves coolant access at point of contact
- Proprietary resin system improves adhesion to substrate
- Uniform 3 mil polyester film backing, ensures film flatness and improved part geometry
- Compatible with most machinery attachments and all coolants, allowing quick film replacement
- Long life and offers high yields, reduced rework, and uses fewer steps for lowest total abrasive costs



Microns	Roll Width	Roll Length	Disc Diameter	Sheet Size
1, 3, 9	$\leq 12''$	50' - 150'	$\leq 12''$	$\leq 12'' \times 12''$
9, 15, 30, 45, 60, 76, 100	$\leq 12''$	50' - 150'	$\leq 12''$	$\leq 12'' \times 12''$
1, 3, 6	$\leq 12''$	50' - 150'	$\leq 12''$	$\leq 12'' \times 12''$

Standard roll \leq widths 50, 100 and 200 mm. Other \leq widths are available on request.

Micron	230 x 280 mm	300mm Ø (PSA)
0.5	362901	362997
1	362549	362998
3	362550	363004
6	362902	363002
9	362903	363001
15	362040	363000
30	362904	362999

Kemet Diamond Lapping Film, Plain Backed

Diaflex - Diamond Grinding

Kemet Diaflex is a self adhesive, flexible diamond material which combines the long life and aggressive cutting action of diamond with the flexibility of cloth. It is supplied in either discs or squares, and a wide range of grit sizes. The diamond is either nickel bonded (N) or resin bonded (R). It is suitable as a grinding step in either metallographic sample preparation or flat lapping. Diaflex can be supplied as plain backed.



Close-up of resin bonded Diaflex

Close-up of nickel bonded Diaflex

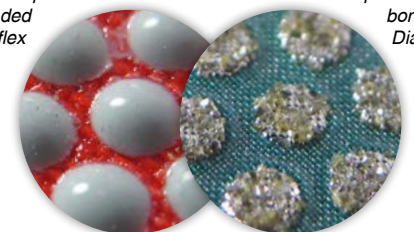







Grade	Grit / Micron Size	Disc (mm)					Square (mm)		
		150	200	230	250	300	100 x 100	150 x 150	300 x 300
Green (N)	60 / 250	342074	342025	342075	342076	342068	342011	342013	342048
Black (N)	120 / 125	342001	342002	342077	342026	342027	342014	342070	342049
Red (N)	200 / 74	342004	342005	342067	342028	342029	342016	342036	342050
Yellow (N)	400 / 40-50	342006	342007	342071	342030	342031	342018	342066	342051
White (N)	800 / 20-30	342032	342008	342072	342033	342034	342020	342037	342052
Yellow / White (R)	800 / 20-30	342078	342035	342079	342080	342047	342038	342044	342053
Blue (R)	1800 / 6-12	342042	342009	342073	342081	342084	342043	342021	342054
Orange (R)	12000 / 1-3	342069	342010	342082	342083	342085	342022	342023	342055

Kemet Polishing Pads

Flat polished surfaces on many softer materials can only be produced with polishing pads. Available to suit most grinder/polisher and flat lapping machines, Kemet offers the widest range of self-adhesive and metallic backed polishing pads. These are generally split into three types: Chemo-textile, Nap and Synthetic Silk

Type	Description	Square (mm)
		127 x 127
Sphericroth A	For general purpose, single use spherical polishing pads.	341998
Sphericroth B		341966
NLH	For high gloss spherical polishing	341276

Name	Type	Description	Use with Recommended Diamond Micron size	Ø 12"/300mm	Ø 15"/380mm	Ø 24"/610mm	Ø 36"/914mm	Colour
PSU-M	Chemo-textile These are manufactured to the highest standards with accurately controlled uniform thickness. Self-adhesive. Non-woven pads manufactured specially for polishing processes.	These medium and hard chemo-textile cloths are for smoothing and polishing operations.	15 micron and finer	341010	341011	341012	341035	
PSU-MM (magnetic)				341813	341814	341837	341838	
NSH-B	Nap Cloths For final polishing stages of preparation, Kemet Nap Type Cloths are available with a range of softness and nap length. They give a more gentle polish, and are ideal for softer specimens and components. All cloths are self-adhesive unless marked 'plain'.	A short nap cloth with woven backing used for metallographic and some optical polishing operations.	3 micron and finer	341203	341243	-	341259	
NSH-BM (magnetic)				341262	341264	341265	341266	
NLH		A longer, stiffer nap cloth.	6 micron and finer	341206	341248	-	-	
NLH-M (magnetic)				341267	341296	-	-	
CHEM-H		For use with a chemical mechanical polishing process with colloidal silica suspension.		341784	341865	341786	341866	
CHEM-HM (magnetic)				341853	341854	341856	341855	
MRE		Synthetic flock on a flexible waterproof carrier. A more heavy duty cloth.	6 micron and finer	341714	341715	341877	341942	
MRE-M (magnetic)				341817	341818	341819	341828	
ASFL	Synthetic Silk Durable woven structure, developed for finishing metal specimens and components.	Synthetic silk pad with durable woven structure for mirror finishing of most metals.	6 micron and finer	341111	341112	341113	341140	
ASFL-M (magnetic)				341177	341178	341179	-	
MSFL		Will polish metal flat, and to a mirror finish.	3 micron and finer	341755	341756	341757	341759	

Supplied in packs of 10. Other sizes available on request.

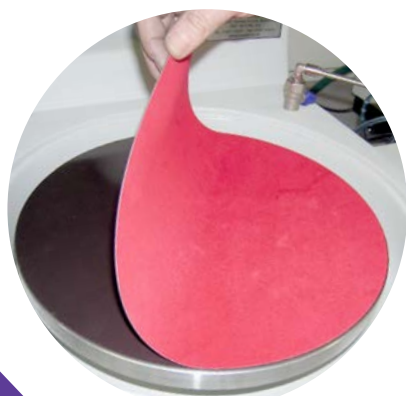

Magnetic Polishing Pad Systems

The Kemet magnetic disc system is suitable for Kemet's range of magnetic polishing pads (marked 'magnetic' above), diamond grinding and fine grinding discs, and any magnetic consumable from other suppliers.

- Easy to change and cloths last longer
- No adhesive breakdown problems
- Faster and cleaner cloth changes
- No metal disc involved so safe to use

Magnetic Disc Size	Code
Ø 300 mm / 12"	345772
Ø 380 mm / 15"	345773
Ø 610 mm / 24"	345774
Ø 914 mm / 36"	345775

Workholding and Holders

Workholding is one of the most important factors when carrying out a lapping operation. The flatness of a part can be adversely affected by incorrect workholding.

For continuous lapping of the same range of parts, it makes sense to have sets of profiled workholders. A full range of blank workholders 3mm or 6mm thick are available. We can also supply pre-profiled workholders on request.

Lapping Machine	Diameter	Thickness	Code
Kemet 15	138mm	3mm	360206
Kemet 15	138mm	6mm	360678
Kemet 20	189mm	3mm	362460
Kemet 24 (3 ring)	246mm	3mm	360269
Kemet 24 (3 ring)	246mm	6mm	360232
Kemet 36 (3 ring)	366mm	3mm	360280
Kemet 36 (3 ring)	366mm	6mm	360285
Kemet 48 (3 ring)	503mm	6mm	360248
Kemet 56 (3 ring)	576mm	6mm	362498



Kemet Facing kit

The Kemet facing kit consists of a non-skid rubber pad. This pad can be fixed to the bottom surface of the hand weight to hold parts without a workholder and protect the parts being lapped. The hand weight with the pad is then placed directly on top of the parts which have been positioned inside the conditioning ring. Lapping can occur and the parts will not skid out of position.

Lapping Machine	Code
Kemet 300L	362458
Kemet 15	361503
Kemet 20	361972
Kemet 24	361504
Kemet 36	361509



Dycem

This non-slip material has a protective film on both sides, which will keep the material clean until ready to use.

Dimensions: 406 mm x 9 m

Product	Code
Dycem	361505



Foam Tape

Double sided self-adhesive foam tape. Dimensions: 3 mm thick, 50 mm wide and 25 m long. Use in combination with Dycem

Product	Code
Foam Tape	361506



Polishing Stand with Paper

Recommended for polishing workpieces to produce reflection needed for viewing under monochromatic light sources.

The heavy-duty polishing table is provided with a tensioning mechanism for smooth pulling of the polishing paper.

Product	Code
Hand Polishing Paper 50 m x 305 mm	Grit 2000 362162 Grit 3000 362029
Polishing Stand (350 x 280 mm)	361560



Lapping Accessories

Electronic Dispenser System



The Kemet Electronic Dispenser distributes Liquid Diamond and Lubricating Fluid by means of touch sensitive settings. The digital display shows dispensing intervals, durations and air pressure at a glance. The dispenser achieves great accuracy, eliminating wastage and simplifying cost control.

The Kemet Liquid Diamond Stirrer Unit maintains a consistent distribution of diamond particles within the slurry by using a small non-contaminant plastic coated paddle magnet, which ensures even diamond suspension. The Kemet Dual Dispensing Bar can be positioned to dispense Liquid Diamond and Lubricating Fluid accurately on to the plate without spray bounce.

- Supplied as standard with Kemet Flat Lapping and Polishing Machines and Plates
- Easily fitted to existing conventional Flat Lapping Machines to improve productivity
- Fully controlled metering of Liquid Diamond and Lubricating Fluid using independent pressure and time settings
- Electrical system complies with EN 60 204.
- Can also be used as a standalone unit for bespoke applications that require controlled dispensing
- Dispenser Service Kit available to keep the unit in optimal use - Product Code: 362530



Electronic Dispenser				
Height	Width	Depth (exc. air filter)	Nett Weight	Code
150 mm	230 mm	150 mm	3.74kg	360499

Dispenses Kemet Liquid Diamond and Lubricating Fluid automatically at pre-set intervals in conjunction with a lapping and polishing machine cycle timer.

Air requirements: 1 Bar min - 2 Bar max. **Air pressure:** Dual circuit. **Air pressure display:** Bar or psi
Adjustable duration of spray: 1-9 seconds. **Adjustable intervals of spray:** 1-999 seconds
Spray memory: Standard. **Manual override:** Standard
Electrical supply: 110V or 220V - 240V / 50Hz or 60Hz (self adjusting for supply voltage & frequency)



Liquid Diamond Stirrer Unit				
Height	Width	Depth	Power	Code
120 mm	90 mm	215 mm	50Hz or 230V	360534
			60Hz 110V	360536

Quiet electric unit has fully variable speed control and is provided with a magnetic stirrer paddle also holds the bottle for the lubricating fluid



Single Spray Head	
Length	Code
250 mm	360514
380 mm	360512

Supplied with bottle, cap and plastic tubing



Dual Dispensing Bar & Bottles						
Type	Length	Reach	Adjustable Height	Section of head	Bottle capacity	Code
Standard	340 mm	260 mm	100 mm	20 x 20 mm	400ml	360511
Long	495 mm	415 mm	100 mm	20 x 20 mm	400ml	360510

Supplied complete with two bottles and plastic tubing. Fully adjustable head for vertical and radial positioning

aKu-Disp Peristaltic Dispenser

The Kemet aKu-Disp is designed to work in conjunction with Kemet Lapping Machines. The aKu-Disp operates whilst the machine is running to provide accurate metered dosing of abrasive slurry to the lapping/polishing application. The unit's stirrer function begins to operate as soon as power is switched on and variable speed controls for both the pump and stirrer can be adjusted.

Features

- Variable speed stirrer and pump controls
- Constant movement of fluid in tubes when on standby to avoid hardening of abrasive
- Can operate as a stand-alone unit
- Variety of integration kits available
- Health & Safety benefits in enclosed environment
- Auxiliary contact relay for timer integrated control
- Suitable for viscosities up to 1000 Cps at 20°C (68°F)
- Priming function to charge pipe and spray head prior to use
- Voltage: 230V-1phase-50Hz or 110V-1phase-60Hz

	Product	Code
	aKu-Disp unit	362820
	aKu-Disp interface box	362830A
Integration kit for	Kemet 15	362824
	DiaCol 15	362826
	DiaCol 24	362827



Flatness Gauges

The Kemet 9" Flatness Gauge is used to monitor a lapping plate's flatness and to give an indication of the flatness the plate will produce on a given part size. The gauge comes with a calibrated single-sided master setting block and is supplied with instructions.

- Span of Gauge: 9.29" (236mm)
- 1 Micron Accuracy
- Recalibration service available
- Suitable for lapping plates 15" to 36" diameter

Product	Code
9" Flatness Gauge	361304



Colour Coded Flatness Gauge

Kit includes additional features for the flatness gauge, making it much easier and quicker for reading the lapping plate flatness. Suitable for 24 and 36 inch lapping machines.

Product	Code
Colour Coded Flatness Gauge Kit <i>(Different kits available depending on machine & setup)</i>	Contact Kemet



Straight Edges to Measure Plate Flatness

Steel straight edges to measure plate flatness. Manufactured to DIN 874.

Description	For Lapping Machine Model				
	15	20	24	36	48
Length	500mm	500mm	750mm	1000mm	1500mm
Cross section	40mm x 8mm	40mm x 8mm	50mm x 10mm	50mm x 10mm	60mm x 12mm
Code	361501	360864	361502	360239	360861



Maintenance Kits

Maintenance kit for Kemet 36 (and larger) Diamond Lapping machines - Product code: 362220
Electronic Dispenser Service Kit - Product code: 362530



Monochromatic Light Source

Produces clear flatness readings when used with Kemet Optical Flats. The compact designed light is easily transportable and uses a sodium long-life light source. Supplied with a flatness reading interpretation chart.

- Detachable power lead with on / off switch at the side
- CE marked
- Supplied with compliance certificate and instructions

Description	Code
220V model (50 or 60 Hz) with UK plug	361201
230V model (50 or 60 Hz) with European plug	361313
110V model (50 or 60 Hz) with USA plug	361211
35W Sodium lamp	362607

Optical Flats

Produced from Quartz, Kemet Optical Flats are available in single and double sided, 1/4 and 1/10* light band accuracy, in sizes from 25mm up to 600mm diameter**. They are supplied boxed with Interferogram Certificate of Conformity with full traceability to international standards. Special optical flats are available on request.



Size (mm)		Single Sided		Double Sided	
Diameter	Thickness	1/4	1/10	1/4	1/10
25	10	361220	361221	361237	361238
50	10	361222	361223	361215	361239
75	15	361224	361225	361705	361240
100	15	361226	361227	361210	361241
125	20	361228	361229	361242	361214
150	25	361123	361231	361216	361243
200	30	361232	361233	361219	361244
250	35	361234	361235	361217	361245
300	40	361218	361236	361246	361247

* Higher accuracy available on request.

** Larger sizes made to order with configurations such as squares, rectangles and donut shapes and custom thickness are available.



Optical Flat Stands

Large optical flats (250mm diameter and above) are heavy. If they are placed directly onto a thin component such as mechanical seals, they can cause distortion of the component and incorrect light band readings. Kemet Optical Flat Stands allow the part to be placed onto the optical flat surface meaning there is no distortion. They also allow a single large optical flat to be used on a wide range of part sizes.

Optical Flat Cleaning and Care Kit

This Kit is used for cleaning Kemet Optical Flats. Taking special care of these will ensure accuracy and long service.

Product	Code
Optical Flat Cleaning and Care Kit	362555

Kemet offers an Optical Flat reconditioning and calibration service

Pressure Relief Valve Lapping Kit

Incorrect lapping and or the use of improper equipment is a major contributor to seat leakage, which in turn leads to high emission rates and costs in loss of process. Kemet have produced a lapping kit that can be used on Tyco, Crosby, and Anderson Greenwood pressure relief valves.

Description & Contents	Code
15 Lapping / Polishing blocks, double sided (D through T2 orifice sizes). 1 x Applikator of 3 Micron Kemet Diamond Compound. 1 x Applikator of 14 Micron Kemet Diamond Compound. Bramet Silicon Carbide self adhesive papers. Grades 60, 120, 180, 320 Grit. Housed in strong plastic case (Weight approx 11.5 Kg).	352900



Kemet Portable Hand 3 Lap Kit

Suited for flat lapping and polishing by hand. It contains three lapping plates, each with its own grade of Kemet Diamond Compound. This makes it possible to process many components in three stages, from lapping through to polishing. Each lapping plate is backed with anti-slip matting and aluminium backing plate.

Description & Contents	Code
Kemet Composite Plate for lapping, Kemet Composite Plate for smoothing, Kemet Composite Plate for polishing. All 150mm diameter on an aluminium backing plate. 1 x 10g Kemet Diamond Compound Applikation Stick - 25 Micron. 1 x 10g Kemet Diamond Compound Applikation Stick - 8 Micron. 1 x 10g Kemet Diamond Compound Applikation Stick - 3 Micron. 1 x Kemet OS Lubricating Fluid. 1 x Aluminium case with Operating Instructions.	352206



Kemet Carbon Seal Lapping Kit

Kemet have developed a portable kit for dry lapping of carbon mechanical seals. The kit consists of a lapped aluminium substrate and 5 superfine polishing discs. The specially designed discs allow carbon seals to be polished without the need for any added loose abrasive. This alleviates loose abrasive impregnation into the carbon face.

Description & Contents	Code
300mm diameter Kemet lapping plate. Kemet portable case for ease of transport. Special polishing discs (Pack 5). Consumables to extend the life of the lapping discs	352565



Kemet Hand Lap Kits

Kemet hand lap kits allow components to be lapped and/or polished by hand in minutes rather than hours. Ideal for components manufactured from ceramics, tungsten carbide, ni-resist etc. Kemet portable hand lapping kits are also ideally suitable for low volume production, when optimum surface finish is required, and where it is not economical to purchase a lapping or polishing machine.

Type (348mm dia)	Contents	Applikation Stick	Code
Type L Kit (Lapping)	1 x 348mm Kemet Composite Plate 1 x 10g Kemet Diamond Compound Applikation Stick.	25 Micron	352216
Type P Kit (Polishing)	1 x Kemet OS Lubricating Fluid. 1 x Aluminium case with Operating Instructions.	3 micron	352208
Type SP Kit (Super Polishing)		3 micron	352370



Ultrasonic Cleaning & Fluids

Lapping and polishing will always leave contaminants (abrasives, liquids, particles of the component material) on the parts when the process has finished.

Aqueous ultrasonic cleaning is the best solution for removing contamination from lapped and polished parts because the ultrasonic action is "searching" enough for complex parts, whilst at the same time gentle enough to not damage the flat lapped/polished surface. Even mirror polished surfaces can be cleaned in this way without degrading the polished finish.

Kemet have a full range of the most advanced ultrasonic cleaning equipment with new technology that assures maximum cleaning results whatever the condition within the tank. Ideal for multiple part cleaning, or validated part cleaning along with spray cleaning solutions for single part inspection.

For high volume production we can supply multi stage washing rinsing and drying systems, with or without handling systems, and fully enclosed, if required.

Free Ultrasonic Cleaning Trials

After

Before

Before

After

Aluminium (Diamond lapping residue)

Aluminium (Aluminium oxide lapping residue)



Ultrasonic Cleaning Fluids

Kemet are a distributor of NGL with more than 300 high performance formulations providing a solution to most cleaning challenges. The finest in biodegradable cleaning fluids, these are specially formulated concentrated detergents available in neutral, alkaline and acid types.

The detergents work by reducing surface tension, intensifying ultrasonic cavitation, dissolving and binding the contaminants that have been loosened by the ultrasonics.

- Free consultations and trials to adapt formulations to specific requirements and optimise cleaning processes.
- Environmentally aware process development to offer ecological solutions.
- Compatible with Kemet range of ultrasonic cleaners.
- Physiochemical and physical wastewater treatment systems to comply with environmental legislation.

Kemet recommend that any cleaning fluid should be tested on a sample of the component to be cleaned to ensure it does not damage the material and offer free trials to establish the optimum process.

For a full list of ultrasonic cleaners and cleaning fluids download our Kemet Cleaning catalogue

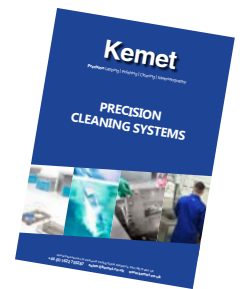

Dasty Industrial Degreaser

For hand cleaning, this product is extremely effective for thoroughly degreasing all mechanical parts as well as large surfaces and perfect for cleaning off lapping residue. Thanks to its ultra-concentrated formula, Dasty easily removes grease, mineral oil, scale, etc. and is biodegradable, safe for shipping and contains no ozone depleting chemicals.

Size	Code
1 Litre	362936
Box of 12	362962

- **Dasty can be used in diluted form in ultrasonic cleaning machines - contact Kemet for more information.**



Hand Cleaning Solutions

CO - 42 Cleaning Fluid

Designed for cold use and applied by spray, brush, cloth or full immersion, CO42 is a highly efficient degreasing fluid similar in performance to 1.1.1 Trichloroethane, but without the ozone depleting properties.

Size	Container	Code
450ml	Trigger Spray	302103
5 Litres	Metal	302102
25 Litres	Metal	302101
200 Litres	Metal	302105

C70 Solvent Cleaning Fluid

A versatile and highly efficient cleaning and degreasing fluid with a fast evaporation rate for removing grease, oil and residues from all metals and ceramics. Supplied in a pressurised container, complete with detachable extended spray tube for reaching into the most difficult areas, C70 contains NO ozone depleting substances.

Size	Container	Code
500ml	Aerosol	302114
500ml	Aerosols (Pk 12)	302115



- C70 and CO-42 are **NOT** approved for use at elevated temperatures or in ultrasonic cleaning machines.

Kemet Technical Centres



Lapping and Polishing Services

If your components require optimum flatness to perform to specification, if they are difficult to lap, or you have a particularly tight deadline to meet, Kemet's Sub Contract Service is the answer. We are renowned for our service, reliability and quality, and we specialise in fast turnaround times. Our machines are equipped with both standard and special lapping plates to enable us to process most types of components. We are able to lap and/or polish components up to 530mm diameter (approx. 21").

All work is returned with a Certificate of Conformity covering the generated surface finish and flatness, relative to the customer's drawing or specification. Kemet Europe B.V. in The Netherlands and Kemet Far East in Singapore also offer lapping and polishing of components for companies who have high surface finish requirements, but don't have the necessary equipment or expertise.

Free Lapping Trials*



Research & Development Facilities

Our R&D and contract lapping centre in Singapore and Shenzhen offer the latest machines and equipment to process a wide variety of materials such as; optical glasses, YAG materials, various filter glasses, Sapphire, Ceramics and much more.



Process Development

We regularly assist customers by developing new products and processes, utilising the very latest in precision flat lapping technology. Customers' samples are evaluated, free-of-charge. Comprehensive reports are issued covering all aspects of the process, including details of abrasive, lapping plate, workholding, inspection, cleaning and the likely consumable costs involved. Here are some of the materials we are able to process:

Acrylic	Ceramic	Gold	Silicon Carbide
Alloys	Chrome Plate	Graphite	Sintered Materials
Alumina	Cobalt Chrome	Inconel (Cobalt/Nickel)	Stainless steel
Aluminium	Compact Disc	Keronite (ceramic)	Steel
Aluminium Nitride	Concrete Cement	Molybdenum	Steel (Hard)
Anodised Aluminium	Copper	Nimonic Steel	Titanium
Beryllium Copper	Diamond Tools	Nickel	Tool Steel
Bone	Epoxy Resin	Piston Rings	Toughened Steel
Boron Carbide	Ferrite	Plastic	Tungsten carbide
Brass	Fibre Optic	Polyetherimide	Tungsten Copper
Bronze	Film Guide	Quartz	Vulcanised Fibre
Carbon	Gallium Arsenide	Sapphire	Zinc Selenide
Carbon Fibre	Germanium	Silicon	Zirconate (Lead) Titanate
Cast iron	Glass	Silicon Aluminium Alloy	

If a material does not appear in the list, please contact Kemet on **+44 (0)1622 755287**. All processed samples are returned with detailed technical process reports including detailed surface finishing measurements, free of charge.

Kemet After Sales Service, Support & Servicing

Our team of in-house technical specialists, dedicated engineers and technical representatives are always on hand to offer advice and assistance. Internationally, our world-wide network of Kemet subsidiary companies and exclusive distributors have fully qualified technicians and engineers to help solve lapping, polishing and ultrasonic cleaning problems. Our laboratories use the latest lapping, polishing and ultrasonic cleaning equipment and surface measurement systems to develop improvements to customers processes or to solve specific lapping and polishing problems.

Repairs & Servicing: Kemet offer a range of options to suit your requirements. These include: A visit by your local Kemet technical representative to assess the problem; Sending the equipment to Kemet for an initial investigation for which a small fee is chargeable; A 'one-off' service visit/assessment by one of our service engineers; A full service agreement tailored to suit your requirements.

After Sales Support: Our After Sales department can work with you to determine the best course of action with your enquiry, defining maintenance requirements and strategy and the resources needed. Kemet offers the full range of accessories and spares required for your equipment. Critical components are held in stock by Kemet and/or our suppliers to provide the fastest possible response. Our commitment is to respond to all after-sales technical enquiries within 24 hours either via phone or email.

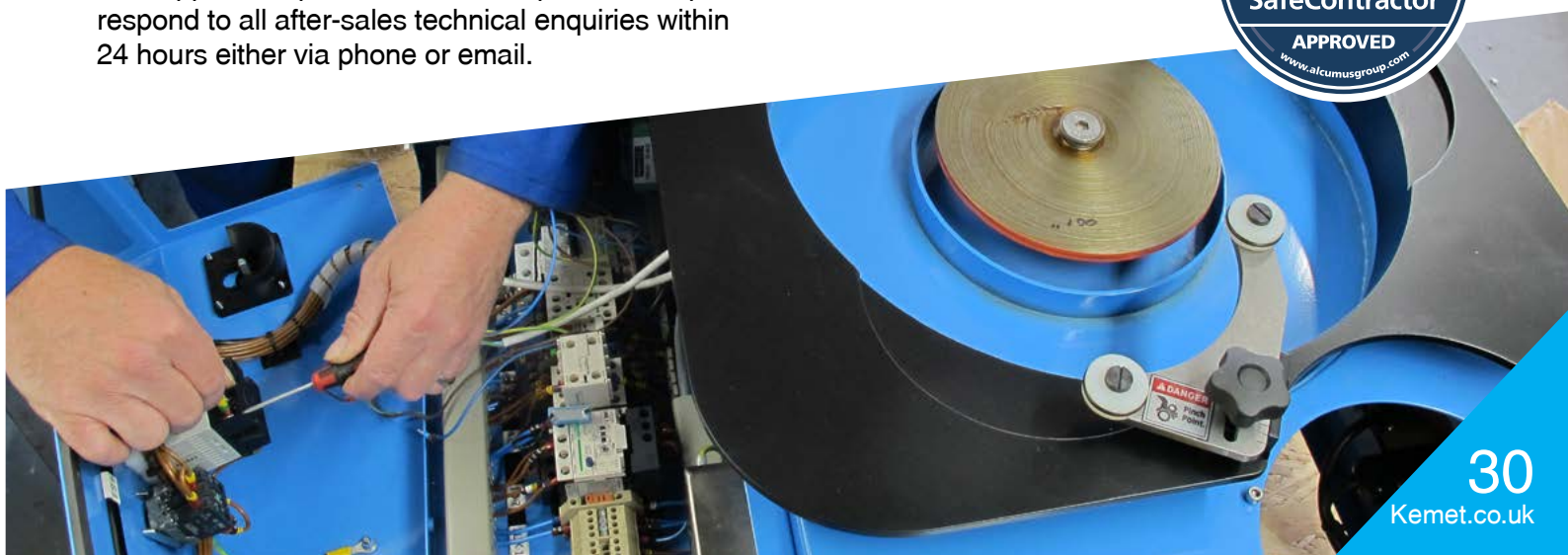

Kemet's Quality Assurance

Kemet operates a Quality Management System which complies with the requirements of ISO 9001:2015 for the following scope: The manufacture of diamond abrasive compounds in solid, paste, liquid and aerosol form for high precision lapping and polishing. The manufacture of composite lap materials produced in a variety of shapes for high-precision lapping and polishing.



Free Sample Testing & Reports



Free Technical Support & Consulting



Over 80 Years of Superior Service



Training

We offer training programmes covering all aspects of lapping and polishing in our Technical Centre or on your site. Courses can be tailored to your specific requirements. These courses are limited to up to 10 people so your specific needs and requirements receive our full attention. The course covers a mixture of theory and practical, but most time is spent getting “hands-on” experience. Typical subjects are:

- Theory of lapping and polishing
- Setting up and operating machines
- Flatness control and measurement
- Types of abrasive
- Lapping plate types
- Workholding methods
- Surface finish measurement
- Product cleaning and inspection

Kemet's Lapping training tablet offers the best alternative to face-to-face training where you can learn at your own pace. The tablet is also ideal if you have received training from Kemet but need a refresher or if you are troubleshooting issues related to Lapping. The training tablet also includes a flatness calculator for working out the required flatness gauge reading to reach your desired flatness and some case studies.





Falling behind? Get lapping!



Components require optimum flatness and/or finish? Are difficult to lap? A tight deadline? Kemet provide a precision lapping and polishing service with a fast turnaround.

Renowned for reliability and quality, our facilities and expertise enable us to lap and polish most components and materials to a specific surface finish and flatness, all with a CoC to a given specification and precision cleaned in our Cleaning Technical Centre. Contact Kemet for a free quotation.

Kemet



Kemet International Ltd. Subsidiary Companies

Singapore

Kemet Far East Pte Ltd

Netherlands

Kemet Europe B.V

Japan / Korea

Kemet Japan / Kemet Korea

Malaysia

Kemet Precision (M) SDN BHD

China

Kemet China Ltd

Australia

Kemet Australia Pty Ltd

Kemet Products are available through a worldwide Network of Authorised Distributors in

Europe
Asia

Africa
Americas

Middle East
Australasia

Kemet International Ltd, Parkwood Trading Estate, Maidstone, Kent, ME15 9NJ, UK

+44 (0) 1622 755287 sales@kemet.co.uk www.kemet.co.uk